

### Open Frame Type Switching Power Supply

#### FEATURES

- U-Channel, End fan and Top fan types available
- Optional high efficiency OR-ing FET diode Current share function
- 2 year warranty

#### ELECTRICAL SPECIFICATIONS

- Input range : 90-264VAC
- Frequency : 47 - 63Hz
- Power Factor : > 0.95 @115VAC; > 0.90 @230VAC @full load
- Inrush current : < 25A peak @115VAC; < 50A peak @230VAC cold start @25°C
- Input current (rms) : 6A @115VAC; 3A @230VAC max.
- Efficiency : > 83% typical @full load, 115VAC
- Leakage current : < 300uA @264VAC
- Maximum power : 500 Watts with 30CFM forced air cooling (U-channel type)
- Hold-up time : > 20ms typical @360 watt load, 115VAC
- Short circuit protection : Auto recovery
- Over load protection : 110% to 150% maximum rating, Auto-recovery
- Over voltage protection : 130% max. above nominal output, shutdown and latch off
- Current share (Single wire) : Up to 4 units can be paralleled [Optional] within 10% accuracy at full load.
- Remote inhibit function
- +5VSB/0.25A convection cooling, 1.0A forced air cooling
- +12V/1A DC fan Output

#### ENVIRONMENTAL

- Operating temperature : 0 to +70°C (Refer to derate curve on the last page)
- Humidity: Non-condensing 5% to 95%
- MTBF : > 100,000 hours @full load and 25°C ambient temperature

#### DC OUTPUT & FEATURES

Model No. ( Note 1 )	Output Voltage	Minimum Load	Maximum Load Convection (Note 2)	Maximum Load (Note 3)	Output Watts	O/P Regulation (Note 4)	Ripple & Noise(Vp-p) (Note 5)
PW-500B-1Y120-X (D)	+12V	0A	30A	41.67A	500W	±1%	120mV
PW-500B-1Y240-X (D)	+24V	0A	15A	20.84A	500W	±1%	240mV
PW-500B-1Y300-X (D)	+30V	0A	12A	16.67A	500W	±1%	300mV
PW-500B-1Y360-X (D)	+36V	0A	10A	13.89A	500W	±1%	360mV
PW-500B-1Y480-X (D)	+48V	0A	7.5A	10.42A	500W	±1%	480mV
PW-500B-1Y540-X (D)	+54V	0A	6.67A	9.26A	500W	±1%	540mV
PW-500B-1Y570-X (D)	+57V	0A	6.32A	8.78A	500W	±1%	570mV

- Note:** 1. Option: X=U, U-Channel, X=S, End Fan, X=T, Fan on top; D=Current share  
 2. Option U, max output 360W @ +40°C ambient max.  
 3. Option U: max output 500W force air 30CFM cooling, Option S and T: max output 500W, +50°C ambient max.  
 4. At 25°C including initial tolerance, line voltage, load currents and output voltages adjusted to factory settings.  
 5. Ripple and noise are measured at oscilloscope 20MHz bandwidth by a 10uF electrolytic capacitor and a 0.1uF ceramic capacitor in parallel at output connector.



#### RoHS compliant

##### U-channel type

Dimension : L203.2 × W118.5 × H42.0 mm ( 8" × 4.66" × 1.65" )

Weight : 0.86 kgs. (1.90 lbs.)

##### End Fan type (40x40x20mm DC Fan)

Dimension : L229.4 × W118.5 × H43.0 mm ( 9.03" × 4.66" × 1.69" )

Weight : 0.98 kgs. (2.16 lbs.)

##### Top Fan type (60x60x15mm DC Fan)

Dimension : L203.2 × W118.5 × H66 mm ( 8" × 4.66" × 2.60" )

Weight : 0.99 kgs. (2.18 lbs.)

#### SAFETY STANDARDS

UL UL60950-1

UL UL62368-1

CSA CSA-C22.2 No.60950-1

CSA CSA-C22.2 No.62368-1

TUV EN60950-1

TUV EN62368-1

CB IEC60950-1

CB IEC62368-1

#### EMC STANDAI

EN55032 Class B

FCC Part 15 Class B

CE



POWER-WIN TECHNOLOGY CORP.

5F-6, No. 79, Sec. 1, Hsin-Tai 5th Road, Shi-Chi, New Taipei City, 22101 Taiwan, R.O.C.

Tel : 886-2-26983989(Rep) Fax : 886-2-26983978

http : //www.power-win.com

E-Mail : sales@power-win.com

REV.2.1

**Open Frame Type Switching Power Supply**

**MECHANICAL SPECIFICATION**

Option : U, U-Channel

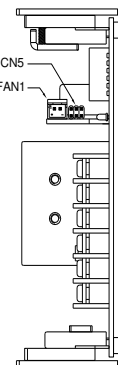
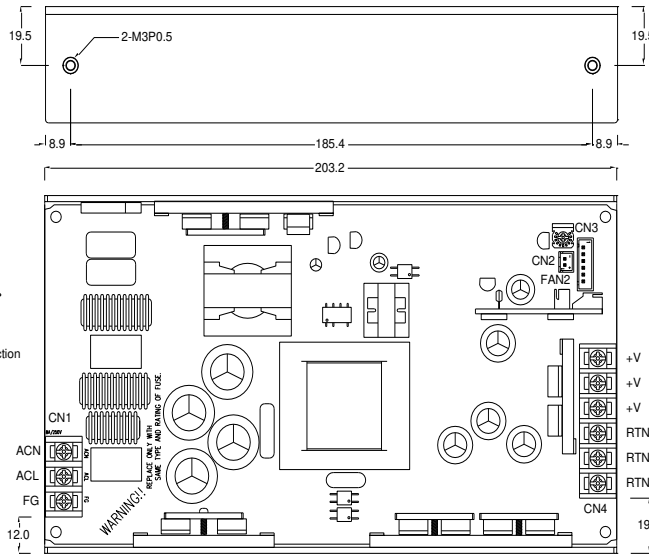
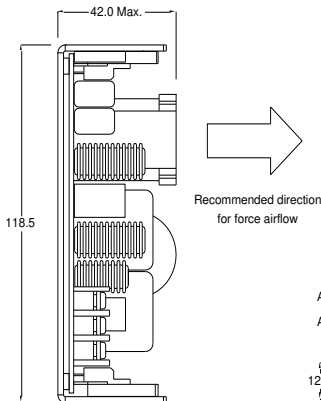
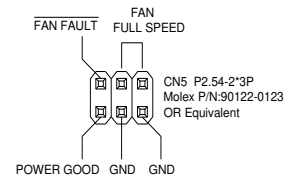
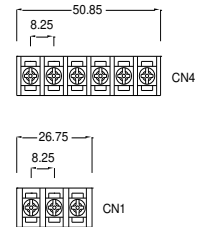
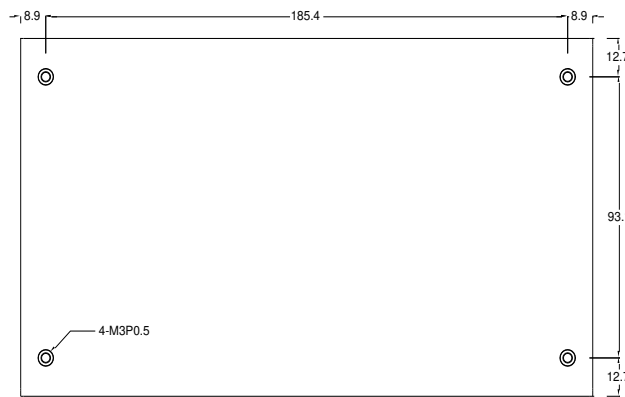

**POWER-WIN TECHNOLOGY CORP.**

5F-6, No. 79, Sec. 1, Hsin-Tai 5th Road, Shi-Chi, New Taipei City, 22101 Taiwan, R.O.C.

Tel : 886-2-26983989(Rep) Fax : 886-2-26983978

http : //www.power-win.com

E-Mail : sales@power-win.com

REV.2.1

**MECHANICAL SPECIFICATION**

Option : S, End Fan

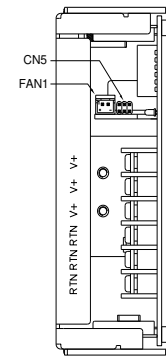
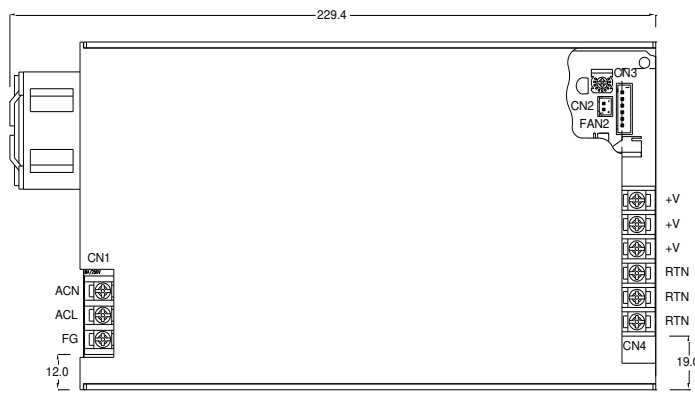
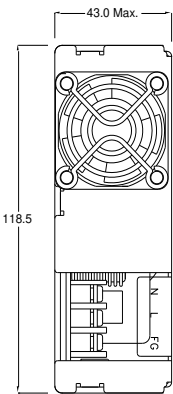
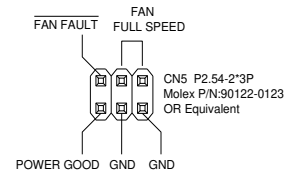
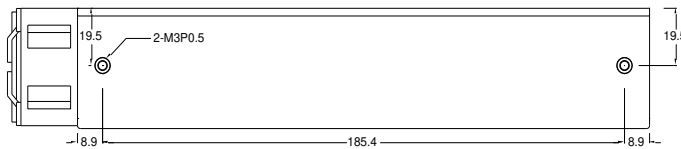
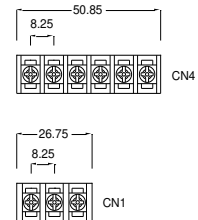
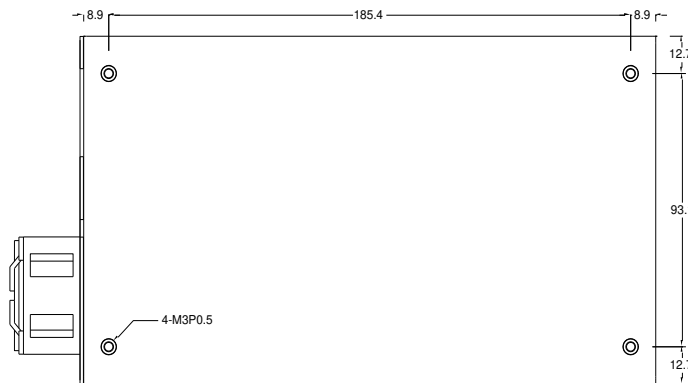
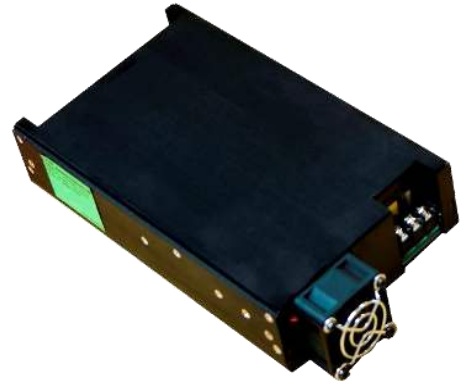

**MECHANICAL SPECIFICATION**

Option : T, Fan on top

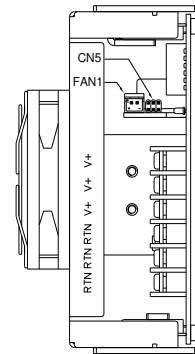
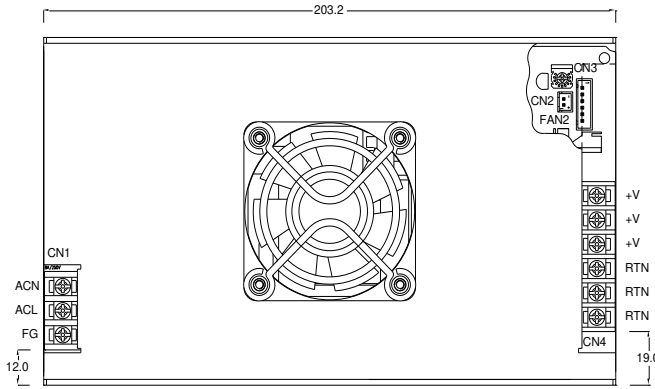
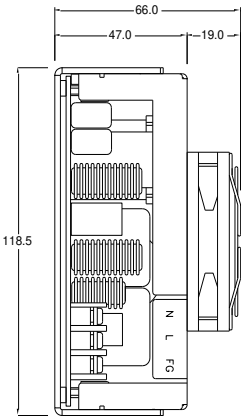
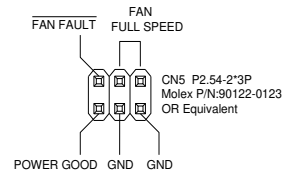
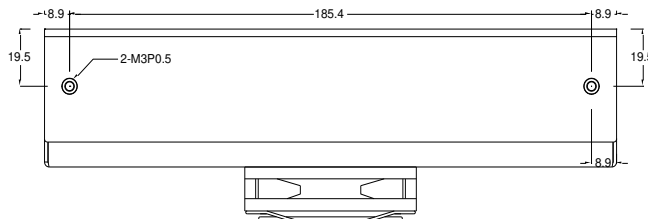
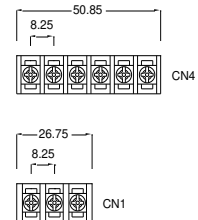
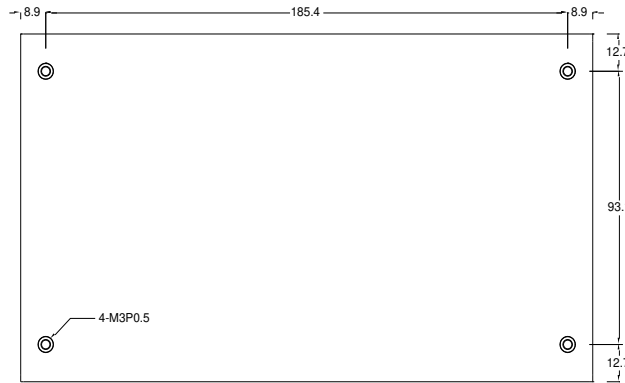

**Open Frame Type Switching Power Supply**

**MECHANICAL SPECIFICATION**

**MATCHING CONNECTORS**

**CN1: Input Connector**

3-Pole Terminal block pitch: 8.25mm rate 20A/300V

Pin #	Signal
1	AC Neutral
2	AC Line
3	F.G.

**CN2: +5VSB Output Connector**

JST B2B-XH-A pitch: 2.5mm or equivalent, mates with female housing JST XHP-2 or equivalent

Pin #	Signal
1	+5VSB
2	GND

**CN3: Remote Sense Connector**

JST B6B-XH-A pitch: 2.5mm or equivalent, mates with female housing JST XHP-6 or equivalent

Pin #	Signal
1	Sense +
2	Sense -
3	+5VSB
4	GND
5	INHIBIT (Remote control)
6	Current Share

INHIBIT: Logic level HIGH(+5V): Enable, Logic level LOW: Disable(0V)

**CN4: Main Output Connector**

6-Pole Terminal block pitch: 8.25mm rate 20A/300V

Pin #	Signal
1	+Vo
2	+Vo
3	+Vo
4	RTN
5	RTN
6	RTN

**FAN1: Fan Output Connector**

JST S2B-XH-A pitch: 2.5mm or equivalent, mates with female housing JST XHP-2 or equivalent

Pin #	Signal
1	+12VDC FAN+
2	+12VDC FAN-

**FAN2: Fan Output Connector**

JST B2B-XH-A pitch: 2.5mm or equivalent, mates with female housing JST XHP-2 or equivalent

Pin #	Signal
1	+12VDC FAN+
2	+12VDC FAN-

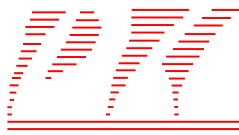

**Open Frame Type Switching Power Supply**

**MECHANICAL SPECIFICATION**

**CN5: Fan control & Power Good Signal Connector**

JST RF-H062TD-1130 pitch: 2.54mm or equivalent, mates with female housing JST RF-06 or equivalent

Pin #	Signal
1	FAN FAULT
2, 3	FAN FULL SPEED
4	POWER GOOD
5	GND
6	GND

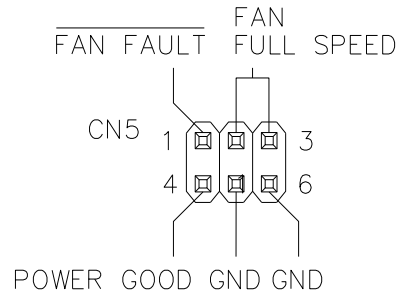

FAN FAULT: Fan status indication, Fan Good: Logic level HIGH(+5V), Fan Fault: Logic level LOW(0V)

FAN FULL SPEED: Short these 2 pins ( #2 and #3 ) with mini-jumper to get highest fan speed

POWER GOOD: Power Good: Logic level HIGH(+5V), Power Fault: Logic LOW(0V)

**DERATING CURVE**

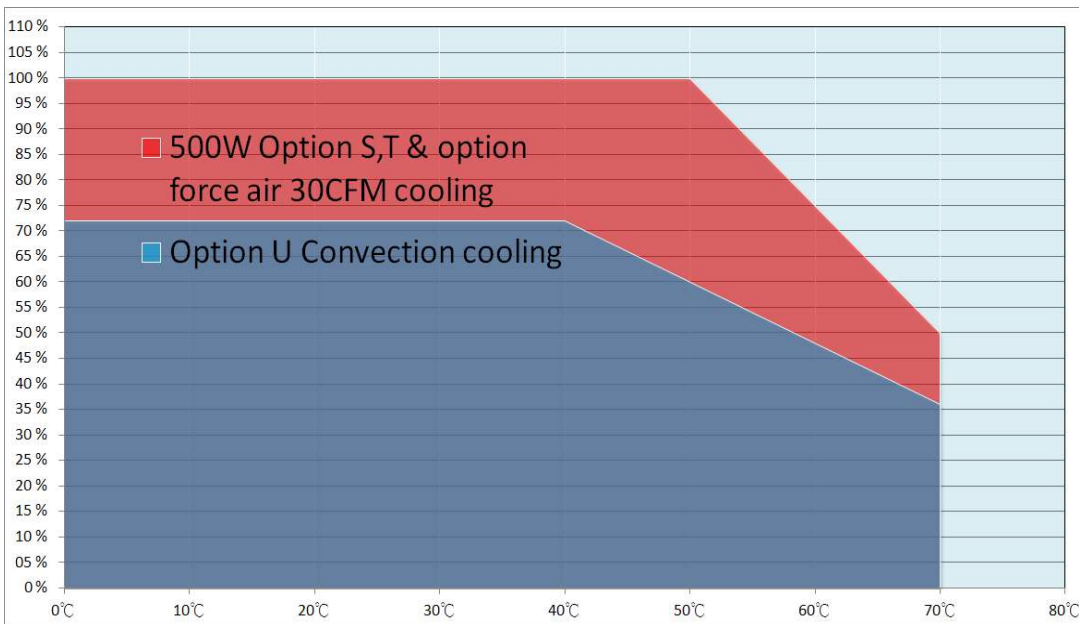

**POWER-WIN TECHNOLOGY CORP.**

5F-6, No. 79, Sec. 1, Hsin-Tai 5th Road, Shi-Chi, New Taipei City, 22101 Taiwan, R.O.C.

Tel : 886-2-26983989(Rep) Fax : 886-2-26983978

http : //www.power-win.com

E-Mail : sales@power-win.com

REV.2.1

## Want to know more?

For sales, technical support or additional information please get in touch with our team of experts.

### ADDITIONAL SERVICES

## We provide an end-to-end service

From the initial consultation and sourcing unique components to supplying bespoke solutions including a full design and build process.

### Bespoke services

Customised and curated technology solutions across the full range of Conexa Tech products

### Sourcing

A full suite of electronics, cable, and mechanical sourcing capabilities

### Design & Build

Development and manufacturing services

hello@conexotech.com | +44 118 402 3430

CONEXATECH.COM