

MEK2S Series

2W, Unregulated Single or Dual Output, 3KV Isolation, SIP7 Package DC/DC Converters

Features

- ▶ Rated power: 2W Max
- ▶ Input voltage range $\pm 10\%$
- ▶ Unregulated single or dual output
- ▶ High efficiency, up to 90%
- ▶ Small no load input current
- ▶ Isolation voltage 3KVDC
- ▶ Operating temperature range: $-40 \sim +105^{\circ}\text{C}$ ambient
- ▶ RoHS compliant
- ▶ Industrial standard SIP7 package
- ▶ Continuous short circuit protection
- ▶ Designed to meet EN/IEC 62368-1
- ▶ 3 year warranty



Overview

The MEK2S series are unregulated SIP7 package DC/DC converters with single or dual outputs, and 3KVDC isolation. These converters feature high efficiency, low ripple and noise, continuous short circuit protection, and wide operating temperature range. They are widely used in distributed power system in industrial applications where isolation and voltage converting is needed.

Model Numbers

Model Number	Input Voltage [VDC] $\pm 10\%$	Output Voltage [VDC]	Output Current [mA]		Efficiency [%] Typ.	Capacitive Load [μF] Max.
			Max.	Min.		
MEK2S-0303	3	3.3	400	40	82	2400
MEK2S-0305	3	5	400	40	83	2400
MEK2S-0309	3	9	222	22	84	1000
MEK2S-1312	3	12	167	17	85	820
MEK2S-0503	5	3.3	400	40	83	2400
MEK2S-0505	5	5	400	40	85	2400
MEK2S-0509	5	9	222	22	85	1000
MEK2S-0512	5	12	167	17	86	820
MEK2S-0515	5	15	133	13	87	680
MEK2S-0524	5	24	83	8	88	560
MEK2S-1203	12	3.3	400	40	84	2400
MEK2S-1205	12	5	400	40	85	2400
MEK2S-1209	12	9	222	22	86	1000
MEK2S-1212	12	12	167	17	87	820
MEK2S-1215	12	15	133	13	88	680
MEK2S-1224	12	24	83	8	89	560

Model Numbers [continued]

Model Number	Input Voltage [VDC]	Output Voltage [VDC]	Output Current [mA]		Efficiency [%] Typ.	Capacitive Load [μ F] Max.
			Max.	Min.		
MEK2S-2403	24	3.3	400	40	84	2400
MEK2S-2405	24	5	400	40	86	2400
MEK2S-2409	24	9	222	22	87	1000
MEK2S-2412	24	12	167	17	88	820
MEK2S-2415	24	15	133	13	89	680
MEK2S-2424	24	24	83	8	90	560
MEK2S-0503D	5	\pm 3.3	\pm 303	\pm 30	83	1000
MEK2S-0505D	5	\pm 5	\pm 200	\pm 20	85	1000
MEK2S-0509D	5	\pm 9	\pm 111	\pm 11	85	560
MEK2S-0512D	5	\pm 12	\pm 83	\pm 8	86	560
MEK2S-0515D	5	\pm 15	\pm 67	\pm 7	87	220
MEK2S-1203D	12	\pm 3.3	\pm 303	\pm 30	84	1000
MEK2S-1205D	12	\pm 5	\pm 200	\pm 20	85	1000
MEK2S-1209D	12	\pm 9	\pm 111	\pm 11	86	560
MEK2S-1212D	12	\pm 12	\pm 83	\pm 8	87	560
MEK2S-1215D	12	\pm 15	\pm 67	\pm 7	88	220
MEK2S-2403D	24	\pm 3.3	\pm 303	\pm 30	84	1000
MEK2S-2405D	24	\pm 5	\pm 200	\pm 20	86	1000
MEK2S-2409D	24	\pm 9	\pm 111	\pm 11	87	560
MEK2S-2412D	24	\pm 12	\pm 83	\pm 8	88	560
MEK2S-2415D	24	\pm 15	\pm 67	\pm 7	89	220

* Only typical models are listed. Other models may be available upon request.

* For dual output models, max capacitive load stipulated in the above list is for each output.

* See ME2S series for 1.5KVDC isolation models, and MEG2S series for 6KVDC isolation models.

Electrical Specifications

Unless otherwise indicated, specifications are measured at $T_A=25^{\circ}\text{C}$, nominal input voltage, full load after warm up.

Parameters	Conditions	Min.	Typ.	Max.	Unit	Note
Input current Full load	$V_{IN}=5\text{V}$		506			
	$V_{IN}=9\text{V}$		268			
	$V_{IN}=12\text{V}$	-	208	-	mA	
	$V_{IN}=15\text{V}$		167			
	$V_{IN}=24\text{V}$		104			
Input current No load		-	4	15	mA	
Reflected Ripple Current		-	15	-	mA	
Surge voltage 1 second max	$V_{IN}=5\text{V}$	-0.7		9		
	$V_{IN}=9\text{V}$	-0.7		12		
	$V_{IN}=12\text{V}$	-0.7	-	18	VDC	
	$V_{IN}=15\text{V}$	-0.7		21		
	$V_{IN}=24\text{V}$	-0.7		30		
Output voltage accuracy	All models	Refer to graphic in "Characteristic Curves" section				
Line regulation For V_{IN} change of $\pm 1\%$	$V_{OUT}=3.3\text{V}$	-	± 1.5	-	%	
	All others		± 1.2			
Load regulation $I_{OUT}=10\%$ to 100% of $I_{OUT, rated}$	$V_{OUT}=3.3\text{V}$		14			
	$V_{OUT}=5\text{V}$		10			
	$V_{OUT}=9\text{V}$	-	9	-	%	
	$V_{OUT}=12\text{V}$		8			
	$V_{OUT}=15\text{V}$		7			
	$V_{OUT}=24\text{V}$		6			
Temperature coefficient	Full load	-	-	± 0.03	$\%/^{\circ}\text{C}$	
Output ripple and noise	20MHz bandwidth	-	60	120	mVp-p	
Output short circuit protection		Continuous, automatic recovery				
Input filter		Capacitor				
Hot plug		None				

* Operating with less than 10% of rated load will not cause permanent damage to the converters, but the performances data may not fall into the specifications, and reliable operating is not assured.

* Dual output models need to operate with balanced load. The load difference between two outputs over 10% may cause unstable operating of the converter.

General Specifications

Parameters	Conditions	Min.	Typ.	Max.	Unit	Note
Isolation voltage Tested for 1 minute, leakage current less than 1mA	Input to Output	3000	-	-	VDC	
Isolation resistance Tested at 500VDC		1000	-	-	M ohm	
Isolation capacitance Tested between input and output, test condition 100KHz, 0.1V		-	20	-	pF	
Operating temperature	See "Derating Curve"	-40	-	+105	°C	
Storage temperature		-55	-	+125	°C	
Temperature rise at case	Full load	-	25	-	°C	
Storage humidity	Non-condensing	-	-	95	%RH	
Switching frequency	Full load	-	220	-	KHz	
Pin soldering resistance 1.5mm away from case for 10 sec		-	-	300	°C	
Vibration		10-150Hz, 5G, 0.75mm along X, Y and Z				
Case material		Black plastic UL94-V0				
Cooling method		Free air convection				
Design based on standards		UL/EN/IEC 62368-1				
Safety certifications		EN/IEC 62368-1				
EMC	Emissions Immunity	CISPR32, EN55032 Class B* IEC/EN61000-4-2				
MTBF	MIL-HDBK-217F	>3,500,000 Hours, T _A =25°C				
Size		19.65 x 7.05 x 10.16 mm				
Weight		1.79g Typ.				

*External circuit is required in order to meet Class B, refer to Figure 2 in Recommended External Circuit

Characteristic Curves

Derating Curve

Output vs Ambient Temperature

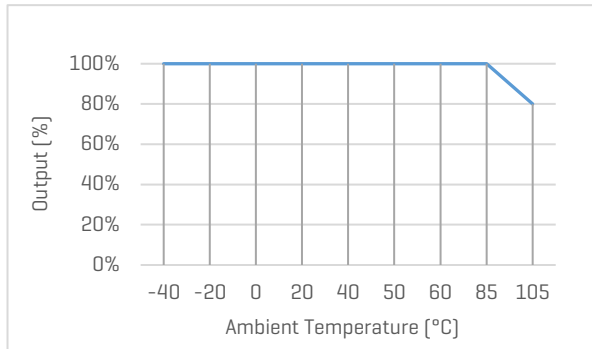

Output Voltage Accuracy vs Load

None 3.3V output models

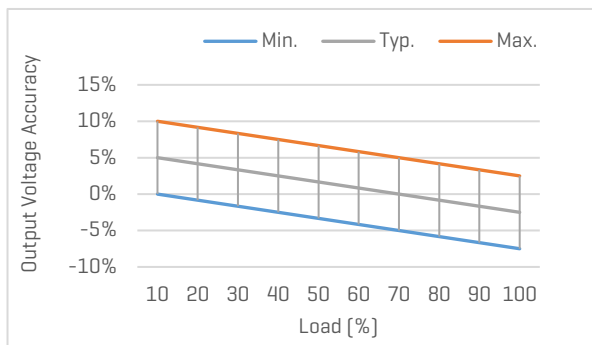

3.3V output models

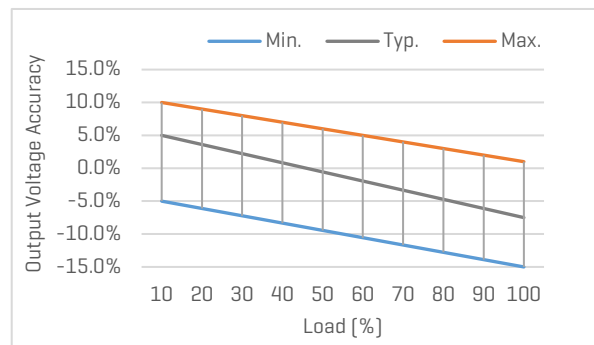

Efficiency Curves

Efficiency vs Input Voltage

MEK2S-0505, with full Load

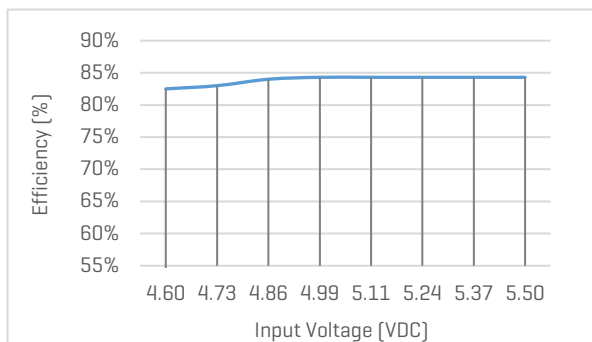

Efficiency vs Load

MEK2S-0505, with nominal input voltage

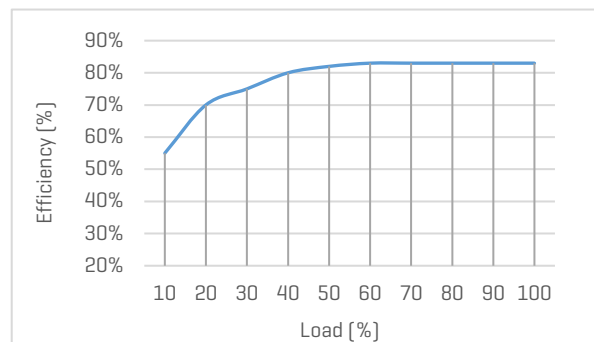

Recommended External Circuit

Typical Application Circuit

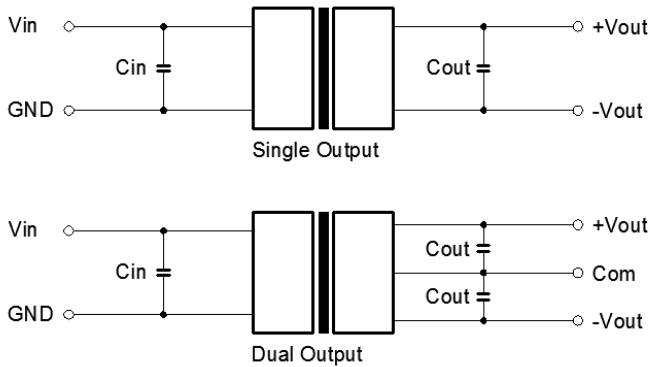

*Typical application circuit is to further lower the input and output ripple. It is not required for general use.

*Recommended component specifications are typical values. Excessive external capacitive load may cause startup problem.

[Table 1] Recommended component spec

V_{IN}	5V	9, 12, 15V	24V
C_{IN}	4.7uF, 16V	2.2uF, 25V	1.0uF, 50V

Figure 1. Typical external circuit

[Table 2] Recommended component spec

V_{OUT}	3.3, 5V	9, 12V	15, 24V
C_{OUT}	10uF, 16V	2.2uF, 25V	1.0uF, 25V

Circuit for EMC Enhancement

*Use this application circuit to meet Class B EMC performance.

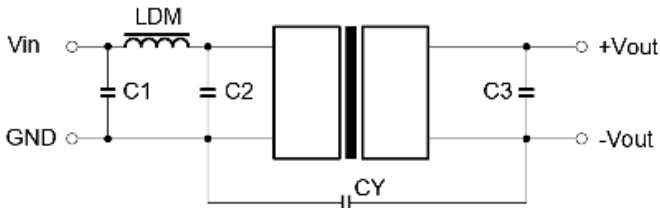

Figure 2. Circuit for EMC enhancement

[Table 3] Recommended component spec

Component	LDM	C1, C2	CY
C_{OUT}	6.8uH	4.7uF, 50V	1nF, 2KV

*C3 refer to C_{OUT} in [Table 2]

Mechanical Specifications

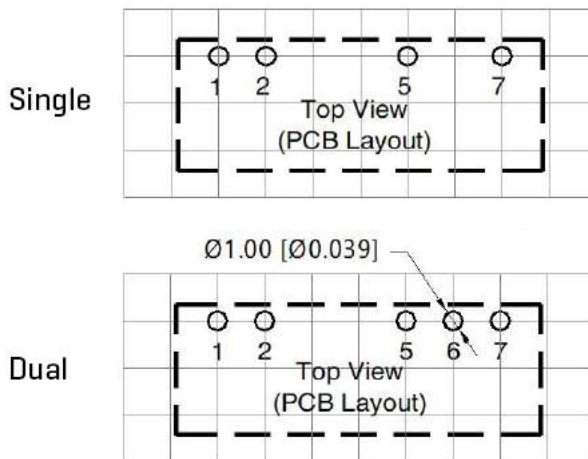
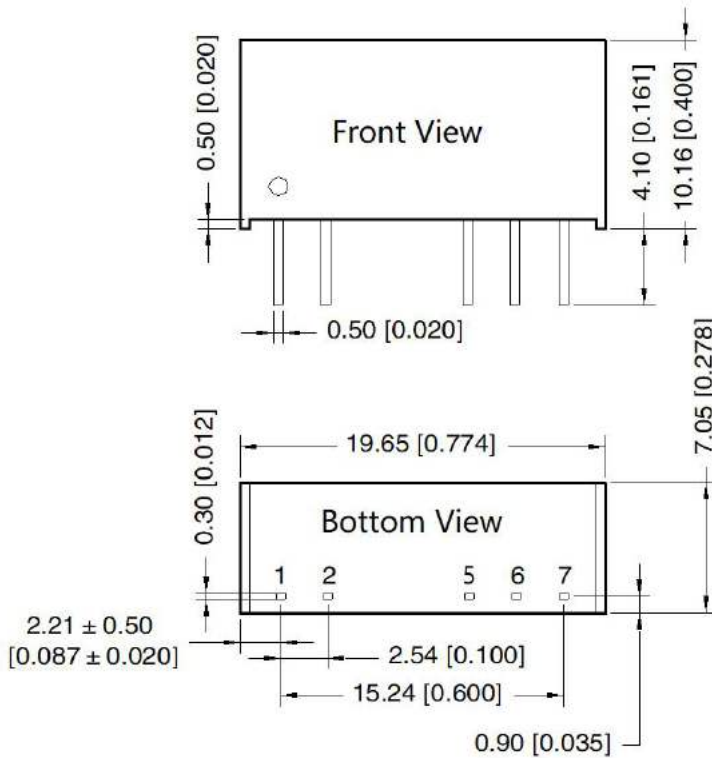

Recommended Footprint

Pin Definition

Pin #	Single Out	Dual Out
1	V _{IN}	V _{IN}
2	GND	GND
5	OV	-V _{OUT}
6	No Pin	OV
7	+V _{OUT}	+V _{OUT}

* Unless otherwise specified unit: mm [inch]

* General tolerance: ± 0.50 [± 0.020]

* Pin thickness: ± 0.10 [± 0.004]

* Footprint grid 2.54 x 2.54 mm

FAVOTEK LIMITED

#17 Canton Road, Tsim Sha Tsui, Kowloon, Hong Kong
 Tel: +852 8191 6662
 Eml: info@favotek.com

Favotek reserves the right to make changes to the product at any time without notice. Information provided by Favotek is believed to be accurate and reliable. However, no responsibility is assumed by Favotek for its use, nor for any infringements of patents or other rights of third parties which may result from its use.

Want to know more?

For sales, technical support or additional information please get in touch with our team of experts.

ADDITIONAL SERVICES

We provide an end-to-end service

From the initial consultation and sourcing unique components to supplying bespoke solutions including a full design and build process.

Bespoke services

Customised and curated technology solutions across the full range of Conexa Tech products

Sourcing

A full suite of electronics, cable, and mechanical sourcing capabilities

Design & Build

Development and manufacturing services

hello@conexotech.com | +44 118 402 3430

CONEXATECH.COM