

MEK1T-D Series

1W, Unregulated Dual Output, 3KV Isolation, SMD Package DC/DC Converters

Features

- ▶ Rated power: 1W max
- ▶ Input voltage range $\pm 10\%$
- ▶ Unregulated dual output
- ▶ High efficiency up to 85%
- ▶ Isolation voltage 3KVDC
- ▶ Small no load input current, only about 3mA
- ▶ Operating temperature range: $-40 \sim +105^{\circ}\text{C}$ ambient
- ▶ RoHS compliant
- ▶ Compact SMD package
- ▶ Continuous short circuit protection
- ▶ Designed to meet UL/EN/IEC 62368-1
- ▶ 3 year warranty



Overview

The MEK1T-D series are unregulated DC/DC converters offered in compact SMD package with 3KVDC isolation. These converters feature high efficiency, low ripple and noise, continuous short circuit protection, and wide operating temperature range $-40 \sim +105^{\circ}\text{C}$. They are widely used in distributed power system in industrial applications where isolation and voltage converting is needed.

Model Numbers

Model Number	Input Voltage [VDC] $\pm 10\%$	Output Voltage [VDC]	Output Current [mA]		Efficiency [%] Typ.	Capacitive Load [μF] Max.
			Max.	Min.		
MEK1T-0303D	3.3	± 3.3	± 152	± 15	77	1200
MEK1T-0305D	3.3	± 5	± 100	± 10	82	1200
MEK1T-0309D	3.3	± 9	± 56	± 5	82	470
MEK1T-0312D	3.3	± 12	± 42	± 5	82	220
MEK1T-0315D	3.3	± 15	± 34	± 4	82	220
MEK1T-0324D	3.3	± 24	± 21	± 2	84	100
MEK1T-0503D	5	± 3.3	± 152	± 15	74	1200
MEK1T-0505D	5	± 5	± 100	± 10	82	1200
MEK1T-0509D	5	± 9	± 56	± 5	83	470
MEK1T-0512D	5	± 12	± 42	± 5	83	220
MEK1T-0515D	5	± 15	± 34	± 4	83	220
MEK1T-0524D	5	± 24	± 21	± 3	85	100
MEK1T-1203D	12	± 3.3	± 100	± 10	82	1200
MEK1T-1209D	12	± 9	± 56	± 6	83	470
MEK1T-1212D	12	± 12	± 42	± 5	83	220
MEK1T-1215D	12	± 15	± 34	± 4	83	220
MEK1T-1224D	12	± 24	± 21	± 3	85	100

MEK1T-D Series

1W, Unregulated Dual Output, 3KV Isolation, SMD Package DC/DC Converters

Model Numbers [continued]

Model Number	Input Voltage [VDC] ±10%	Output Voltage [VDC]	Output Current [mA]		Efficiency [%] Typ.	Capacitive Load [uF] Max.
			Max.	Min.		
MEK1T-1515D	15	±15	±34	±4	83	220
MEK1T-2405D	24	±5	±100	±10	82	1200
MEK1T-2409D	24	±9	±56	±6	83	470
MEK1T-2412D	24	±12	±42	±5	83	220
MEK1T-2415D	24	±15	±34	±4	83	220
MEK1T-2424D	24	±24	±21	±3	85	100

* Only typical models are listed. Other models may be available upon request.

* Operating with less than 10% of rated load will not cause permanent damage to the converters, but the performances data may not fall into the specifications, and reliable operating is not assured.

* Standard models in this series are 3KVDC isolation single output models. See MEK1T for single output, and ME1T series for 1.5KVDC isolation models.

Electrical Specifications

Unless otherwise indicated, specifications are measured at $T_A=25^{\circ}\text{C}$, nominal input voltage, full load after warm up.

Parameters	Conditions	Min.	Typ.	Max.	Unit	Note
Input current Full load	$V_{IN}=3.3\text{V}$		370		mA	
	$V_{IN}=5\text{V}$	-	240	-		
	$V_{IN}=12, 15\text{V}$		108			
	$V_{IN}=24\text{V}$		51			
Input current No load		-	10	-	mA	
Reflected ripple current		-	15	-	mA	
Surge voltage 1 second max	$V_{IN}=3.3\text{V}$	-0.7		5	VDC	
	$V_{IN}=5\text{V}$	-0.7		9		
	$V_{IN}=12\text{V}$	-0.7	-	18		
	$V_{IN}=15\text{V}$	-0.7		21		
	$V_{IN}=24\text{V}$	-0.7		30		
Output voltage accuracy	All models	Refer to graphic in "Characteristic Curves" section				
Line regulation For V_{IN} change of $\pm 1\%$	$V_{OUT}=\pm 3.3\text{V}$	-	-	± 1.5	%	
	All others			± 1.2		
Load regulation $I_{OUT}=10\%$ to 100% of $I_{OUT, rated}$	$V_{OUT}=\pm 3.3\text{V}$		15		%	
	$V_{OUT}=\pm 5\text{V}$	-	10	-		
	All others		8			
Temperature coefficient	Full load	-	± 0.02	-	$\%/^{\circ}\text{C}$	
Output ripple and noise	20MHz bandwidth		30	100	mVp-p	
Output short circuit protection		Continuous, automatic recovery				
Input filter		Capacitor				
Hot plug		None				

* Dual output models need to operate with balanced load. The load difference between two outputs over 10% may cause unstable operating of the converter.

General Specifications

Parameters	Conditions	Min.	Typ.	Max.	Unit	Note
Isolation voltage 1 minute, leakage current <1mA	Input to Output	3000	-	-	VDC	
Isolation resistance Tested at 500VDC	Input to Output	1000	-	-	M ohm	
Isolation capacitance 100KHz, 0.1V	Input to Output	-	20	-	pF	
Operating temperature	See "Derating Curve"	-40	-	+105	°C	
Storage temperature		-55	-	+125	°C	
Case temperature rise		-	25	-	°C	
Storage humidity	Non-condensing	5	-	95	%RH	
Switching frequency	Full load	-	220	-	KHz	
Reflow soldering temperature		Peak temp. 217 - 245°C, maximum duration 60s				
Vibration		10-150Hz, 5G, 0.75mm along X, Y and Z				
Cooling method		Free air convection				
Design based on standards		UL/EN/IEC 62368-1				
Safety certifications		EN/IEC 62368-1				
EMC	Emissions Immunity	CISPR32, EN55032 Class B* IEC/EN61000-4-2				
MTBF	MIL-HDBK-217F	>3,500,000 Hours, T _A =25°C				
Moisture sensitivity level [MSL]		IPC/JEDEC J-STD-020D.1 Level 1				
Size		16.24 x 11 x 7.05 mm				
Weight		1.7g Typ.				

*External circuit is required in order to meet Class B, refer to Figure 2 in Recommended External Circuit

Characteristic Curves

Derating Curve

Output vs Ambient Temperature

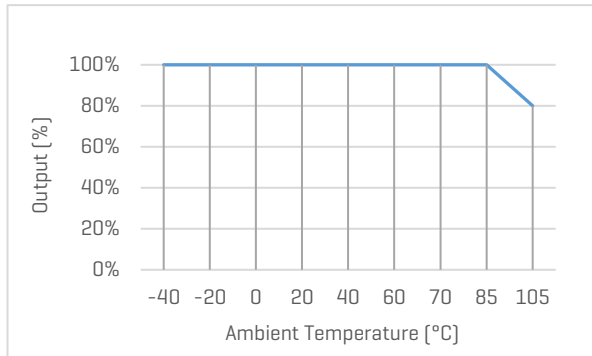

Output Voltage Accuracy vs Load

3.3V input models, and $V_{OUT}=3.3V$

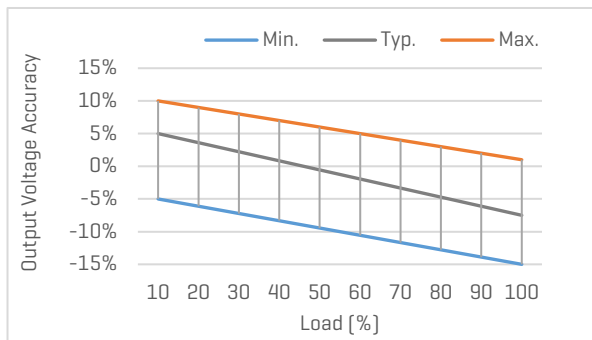

5V input models, and $V_{OUT}=3.3V$

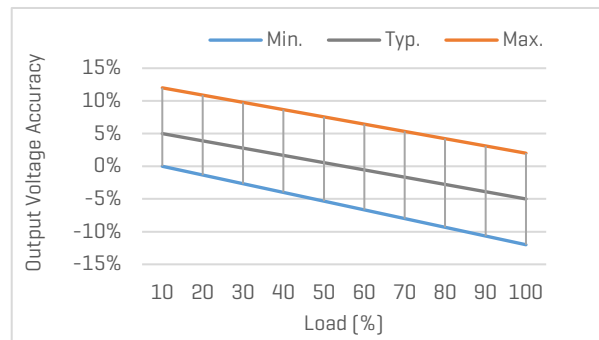

3.3V or 5V input models, and $V_{OUT}=\text{None } 3.3V$

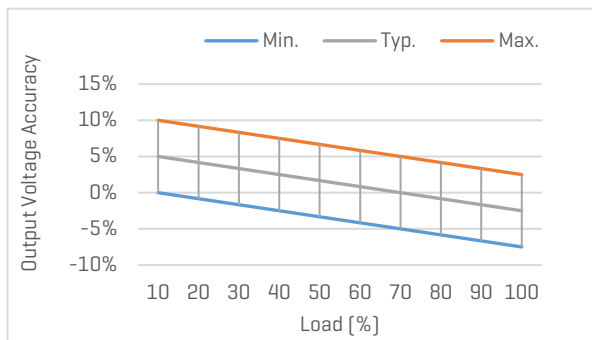

All models with 12, 15, 24V input

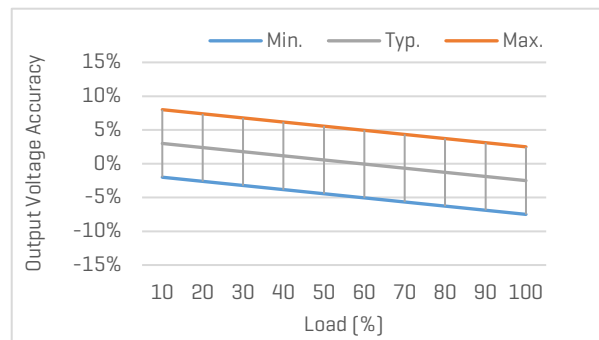

MEK1T-D Series

1W, Unregulated Dual Output, 3KV Isolation, SMD Package DC/DC Converters

Characteristic Curves [continued]

Efficiency Curves

Efficiency vs Input Voltage

MEK1T-0303D, with full Load

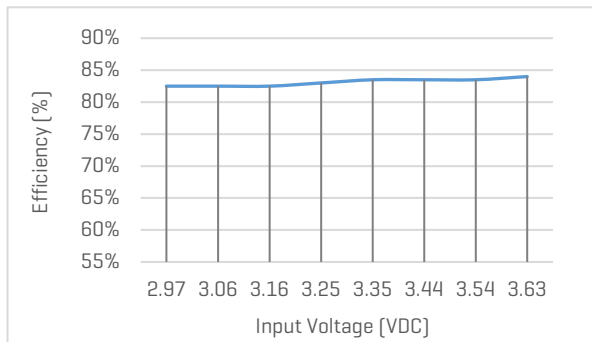

Efficiency vs Load

MEK1T-0303D, with nominal input voltage

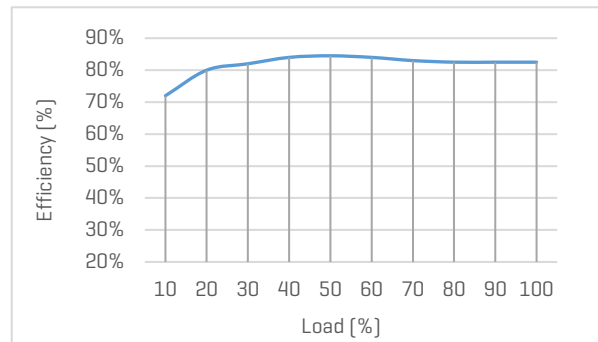

Efficiency vs Input Voltage

MEK1T-0503D, with full Load

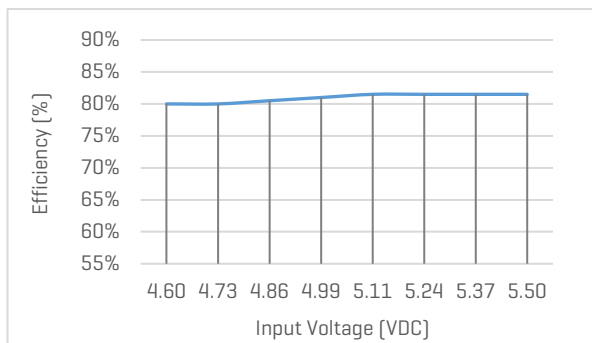

Efficiency vs Load

MEK1T-0503D, with nominal input voltage

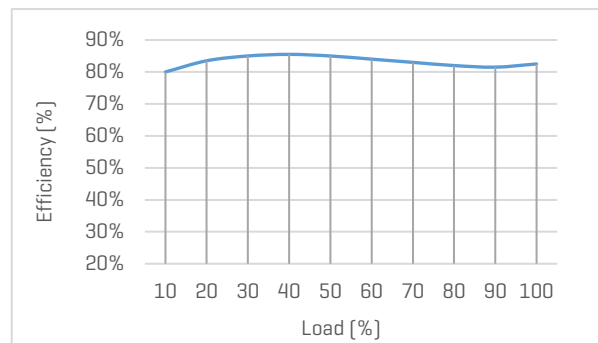

Efficiency vs Input Voltage

MEK1T-1205D, with full Load

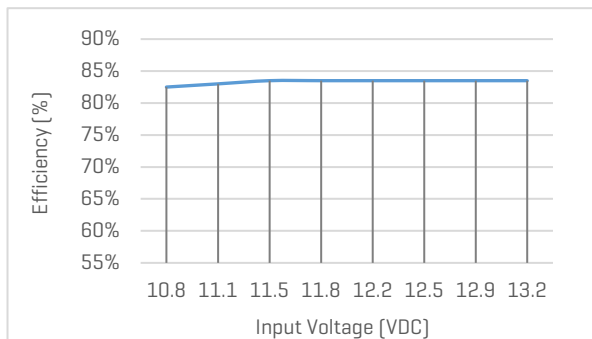

Efficiency vs Load

MEK1T-1205D, with nominal input voltage

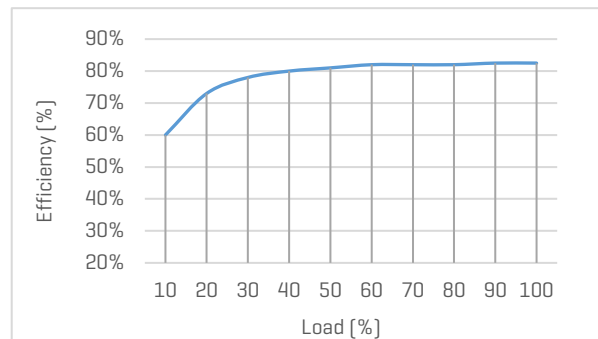

MEK1T-D Series

1W, Unregulated Dual Output, 3KV Isolation, SMD Package DC/DC Converters

Recommended External Circuit

Typical Application Circuit

*Typical application circuit is to further lower the input and output ripple. It is not required for general use.

*Recommended component specifications are typical values. Excessive external capacitive load may cause startup problem.



Figure 1. Typical external circuit

[Table 1] Recommended component spec

Input voltage	3.3V	5V	12V	15V	24V
C_{IN}	10uF, 16V	4.7uF, 16V	2.2uF, 25V	2.2uF, 25V	1uF, 50V

[Table 2] Recommended component spec

Output voltage	±3.3, ±5V	±9V	±12V	±15V	±24V
C_{OUT}	10uF, 16V	2.2uF, 16V	2.2uF, 25V	1uF, 25V	1uF, 50V

Circuit for EMC Enhancement

*Use this application circuit to meet Class B EMC performance.

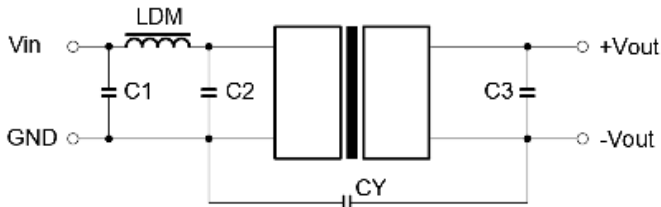

Figure 2. Circuit for EMC enhancement

[Table 3] Recommended component spec

Component	LDM	C1, C2	CY [3.3...9V _{OUT}]	CY [12...24V _{OUT}]
Spec	6.8uH	4.7uF, 50V	100pF, 4KV	1nF, 4KV

*C3 Refer to C_{OUT} in [Table 2]

MEK1T-D Series

1W, Unregulated Dual Output, 3KV Isolation, SMD Package DC/DC Converters

Mechanical Specifications

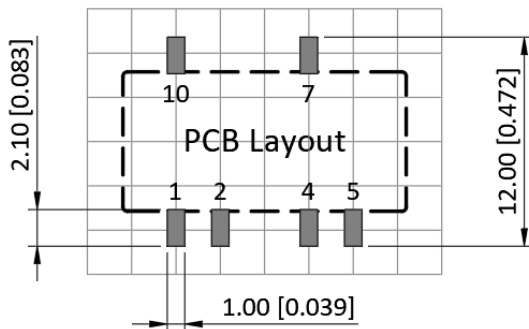
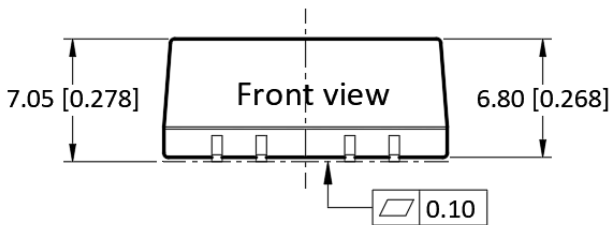
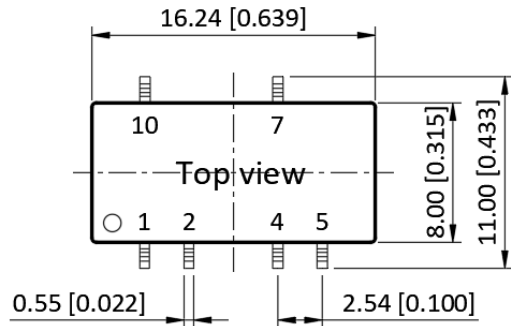

Pin Definition

Pin #	Single Out
1	GND
2	V_{IN}
4	0V
5	$-V_{OUT}$
7	$+V_{OUT}$
10	No connection

* Unless otherwise specified unit: mm [inch]

* General tolerance: ± 0.25 [± 0.010]

* Pin thickness: ± 0.10 [± 0.004]

* Footprint grid 2.54 x 2.54 mm

FAVOTEK LIMITED

#17 Canton Road, Tsim Sha Tsui, Kowloon, Hong Kong
 Tel: +852 8191 6662
 Eml: info@favotek.com

Favotek reserves the right to make changes to the product at any time without notice. Information provided by Favotek is believed to be accurate and reliable. However, no responsibility is assumed by Favotek for its use, nor for any infringements of patents or other rights of third parties which may result from its use.

Want to know more?

For sales, technical support or additional information please get in touch with our team of experts.

ADDITIONAL SERVICES

We provide an end-to-end service

From the initial consultation and sourcing unique components to supplying bespoke solutions including a full design and build process.

Bespoke services

Customised and curated technology solutions across the full range of Conexa Tech products

Sourcing

A full suite of electronics, cable, and mechanical sourcing capabilities

Design & Build

Development and manufacturing services

hello@conexotech.com | +44 118 402 3430

CONEXATECH.COM